

50th years



"thinking panels"

PRICE LIST - \$

2024

About Us

Since the day it was founded, our company has always been preferred by not compromising its innovative line. It is registered that Yespan is a reliable business partner with its history of more than **50 years**. Today, Yespan is an active company that focuses on the production of automation, control and protection panels and exports 70% of its production to more than **40 countries**.

Yespan does not isolate itself from environment. It sees economy, society and environment as integral parts of business life. With this understanding, it strives to be involved in projects prepared for the development of art, sports and the environment.

Yespan needs the right information and people for its success. It works together with universities and follow the technological developments in the world and adapt them to business. Yespan shares the knowledge it has acquired over the years with its employees and business partners and expects from suppliers to act in this direction.

Yespan's **mission** to determine the constantly changing market needs and to produce the most suitable solutions for its business partners by establishing the price-quality balance in this direction.

In addition to its wide product range, Yespan's **vision** is to develop products that meet the sensitive requirements of global companies and to work with them for this purpose.

Aydođan Yıldırım
Founding Chairman

Technical Specifications

Sheet	Door 2 mm CRS Sheet	Enclosure / Mounting Plate 2 mm 275 gr/m ² Galvanized Steel
Coating	RAL 7035 Wrinkle UV resistive polyester coating	
Surface Treatment	Nanoceramic coating / Zirconium oxide	
Protection Class	Indoor IP 55 (According to EN 60529 standards)	

HEIGHT PROFILE SET / E SERIES

HEIGHT	CODE	PRICE (\$)
1400 mm	E YPS 140	121,75
1600 mm	E YPS 160	127,87
1800 mm	E YPS 180	134,24
2000 mm	E YPS 200	137,89
2200 mm	E YPS 220	156,55

HEIGHT PROFILE SET MATERIAL LIST

Height Profile	4 Pcs
Assembly Screw Set	1 Set

E SERIES:

Ask to customer representative for 316 quality stainless steel products.

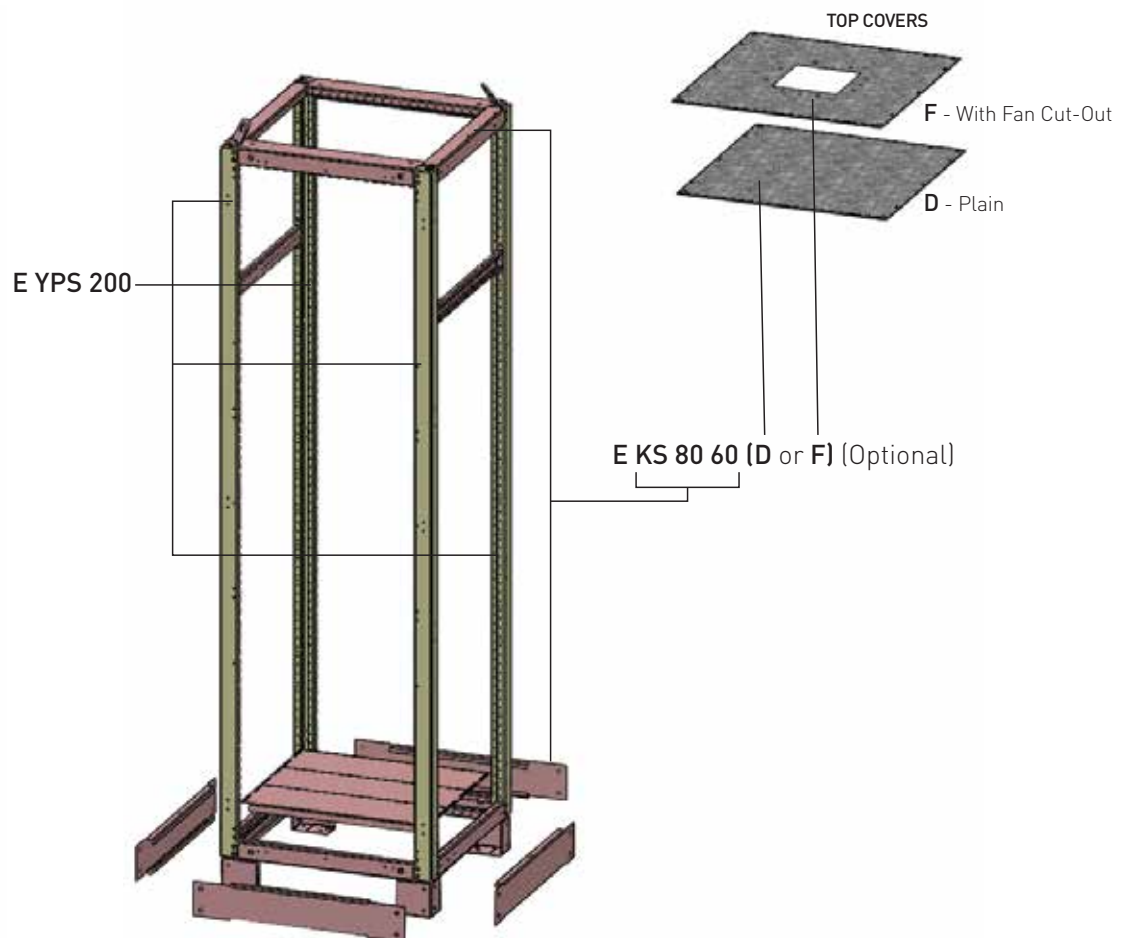

FRAME SET

WIDHT	400 mm DEPTH	
	CODE	PRICE (\$)
400 mm	E KS 40 40 D	180,49
	E KS 40 40 F	184,35
500 mm	E KS 50 40 D	197,94
	E KS 50 40 F	201,98
600 mm	E KS 60 40 D	212,96
	E KS 60 40 F	217,18
700 mm	E KS 70 40 D	223,74
	E KS 70 40 F	228,14
800 mm	E KS 80 40 D	237,99
	E KS 80 40 F	242,03
1000 mm	E KS 100 40 D	283,53
	E KS 100 40 F	287,68
1200 mm	E KS 120 40 D	313,57
	E KS 120 40 F	318,07

FRAME SET

WIDHT	500 mm DEPTH	
	CODE	PRICE (\$)
400 mm	E KS 40 50 D	201,40
	E KS 40 50 F	205,44
500 mm	E KS 50 50 D	222,94
	E KS 50 50 F	227,20
600 mm	E KS 60 50 D	240,83
	E KS 60 50 F	245,31
700 mm	E KS 70 50 D	251,32
	E KS 70 50 F	256,01
800 mm	E KS 80 50 D	267,79
	E KS 80 50 F	272,17
1000 mm	E KS 100 50 D	326,00
	E KS 100 50 F	330,57
1200 mm	E KS 120 50 D	361,78
	E KS 120 50 F	366,79

FRAME SET

WIDHT	600 mm DEPTH	
	CODE	PRICE (\$)
400 mm	E KS 40 60 D	211,83
	E KS 40 60 F	216,04
500 mm	E KS 50 60 D	233,90
	E KS 50 60 F	238,37
600 mm	E KS 60 60 D	252,32
	E KS 60 60 F	257,06
700 mm	E KS 70 60 D	263,34
	E KS 70 60 F	268,34
800 mm	E KS 80 60 D	280,34
	E KS 80 60 F	285,07
1000 mm	E KS 100 60 D	339,62
	E KS 100 60 F	344,62
1200 mm	E KS 120 60 D	376,46
	E KS 120 60 F	381,98

FRAME SET

WIDHT	800 mm DEPTH	
	CODE	PRICE (\$)
400 mm	E KS 40 80 D	269,26
	E KS 40 80 F	273,83
500 mm	E KS 50 80 D	299,51
	E KS 50 80 F	304,42
600 mm	E KS 60 80 D	323,67
	E KS 60 80 F	328,92
700 mm	E KS 70 80 D	334,11
	E KS 70 80 F	339,70
800 mm	E KS 80 80 D	355,55
	E KS 80 80 F	360,95
1000 mm	E KS 100 80 D	440,16
	E KS 100 80 F	446,00
1200 mm	E KS 120 80 D	488,49
	E KS 120 80 F	495,01

FRAME SET MATERIAL LIST

Width Profile	4 Pcs
Depth Profile	4 Pcs
Plinth Corner (h100)	4 Pcs
Front-Back Plinth Cover	2 Pcs
Side Plinth Cover	2 Pcs
Lifting Lug Single	2 Pcs
50 mm Mounting Bracket (Suitable for panel depth)	2 Pcs
Sliding Bottom Plate (With sealing tape)	1 Set
Top Cover (Plain or With Fan Cut-Out)	1 Pc
Assembly Screw Set	1 Set

D - Plain
F - With Fan Cut-Out

REMARKS:

- Mechanical assembly is subject to additional charge.
- Drilling & punching on the components is subject to additional charge.

FRONT DOOR-BACK WALL SET

E SERIES

FREE-STANDING MODULAR ENCLOSURES / IP 55



PLAIN DOOR-BACK WALL SET (Door 2 mm / Back Wall 1 mm)



D
Plain

WIDHT	1400 mm HEIGHT FRONT DOOR-BACK WALL SET		1600 mm HEIGHT FRONT DOOR-BACK WALL SET		1800 mm HEIGHT FRONT DOOR-BACK WALL SET		2000 mm HEIGHT FRONT DOOR-BACK WALL SET		2200 mm HEIGHT FRONT DOOR-BACK WALL SET	
	CODE	PRICE (\$)	CODE	PRICE (\$)	CODE	PRICE (\$)	CODE	PRICE (\$)	CODE	PRICE (\$)
300 mm	E KDS 30 140 D	199,55	E KDS 30 160 D	205,31	E KDS 30 180 D	208,24	E KDS 30 200 D	207,79	E KDS 30 220 D	236,51
400 mm	E KDS 40 140 D	259,96	E KDS 40 160 D	267,99	E KDS 40 180 D	275,22	E KDS 40 200 D	277,30	E KDS 40 220 D	313,91
500 mm	E KDS 50 140 D	279,88	E KDS 50 160 D	290,11	E KDS 50 180 D	299,27	E KDS 50 200 D	302,75	E KDS 50 220 D	343,53
600 mm	E KDS 60 140 D	299,81	E KDS 60 160 D	312,24	E KDS 60 180 D	323,33	E KDS 60 200 D	328,20	E KDS 60 220 D	373,14
700 mm	E KDS 70 140 D	319,74	E KDS 70 160 D	334,36	E KDS 70 180 D	347,39	E KDS 70 200 D	353,65	E KDS 70 220 D	402,76
800 mm	E KDS 80 140 D	339,67	E KDS 80 160 D	356,48	E KDS 80 180 D	371,44	E KDS 80 200 D	379,09	E KDS 80 220 D	432,38
900 mm	E KDS 90 140 D	365,56	E KDS 90 160 D	385,23	E KDS 90 180 D	395,50	E KDS 90 200 D	404,54	E KDS 90 220 D	461,99
*1000 mm	E KDS 5050 140 D	583,02	E KDS 5050 160 D	606,17	E KDS 5050 180 D	626,63	E KDS 5050 200 D	635,10	E KDS 5050 220 D	721,39
*1200 mm	E KDS 6060 140 D	622,99	E KDS 6060 160 D	650,55	E KDS 6060 180 D	674,88	E KDS 6060 200 D	686,14	E KDS 6060 220 D	780,79

* 1000 mm = 500+500 mm
* 1200 mm = 600+600 mm

PERFORATED DOOR-BACK WALL SET (Door 2 mm / Back Wall 1 mm)



M1
Perforated

WIDHT	1800 mm HEIGHT FRONT DOOR-BACK WALL SET		2000 mm HEIGHT FRONT DOOR-BACK WALL SET		2200 mm HEIGHT FRONT DOOR-BACK WALL SET	
	CODE	PRICE (\$)	CODE	PRICE (\$)	CODE	PRICE (\$)
400 mm	E KDS 40 180 M1	285,45	E KDS 40 200 M1	287,09	E KDS 40 220 M1	324,30
500 mm	E KDS 50 180 M1	309,51	E KDS 50 200 M1	312,53	E KDS 50 220 M1	353,91
600 mm	E KDS 60 180 M1	333,57	E KDS 60 200 M1	337,98	E KDS 60 220 M1	383,53
700 mm	E KDS 70 180 M1	357,62	E KDS 70 200 M1	363,43	E KDS 70 220 M1	413,14
800 mm	E KDS 80 180 M1	381,68	E KDS 80 200 M1	388,88	E KDS 80 220 M1	442,76
900 mm	E KDS 90 180 M1	405,73	E KDS 90 200 M1	414,32	E KDS 90 220 M1	472,38
* 1000 mm	E KDS 5050 180 M1	635,91	E KDS 5050 200 M1	654,66	E KDS 5050 220 M1	725,45
* 1200 mm	E KDS 6060 180 M1	683,47	E KDS 6060 200 M1	705,71	E KDS 6060 220 M1	783,74

* 1000 mm = 500+500 mm
* 1200 mm = 600+600 mm

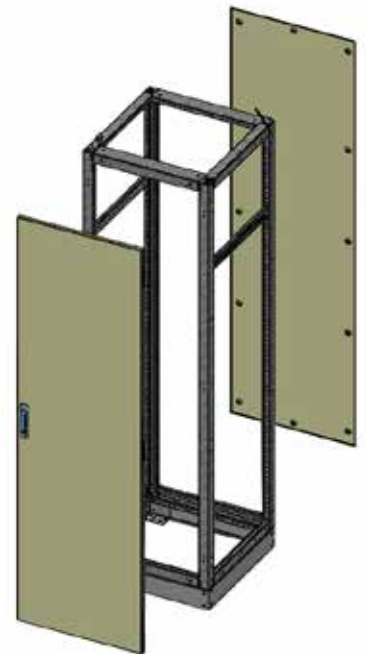

GLAZED DOOR-BACK WALL SET (Door 2 mm / Back Wall 1 mm)



C1
Glazed

WIDHT	1800 mm HEIGHT FRONT DOOR-BACK WALL SET		2000 mm HEIGHT FRONT DOOR-BACK WALL SET		2200 mm HEIGHT FRONT DOOR-BACK WALL SET	
	CODE	PRICE (\$)	CODE	PRICE (\$)	CODE	PRICE (\$)
500 mm	E KDS 50 180 C1	339,46	E KDS 50 200 C1	341,17	E KDS 50 220 C1	384,31
600 mm	E KDS 60 180 C1	363,52	E KDS 60 200 C1	366,62	E KDS 60 220 C1	413,92
700 mm	E KDS 70 180 C1	387,58	E KDS 70 200 C1	392,06	E KDS 70 220 C1	443,54
800 mm	E KDS 80 180 C1	411,63	E KDS 80 200 C1	417,51	E KDS 80 220 C1	473,16
900 mm	E KDS 90 180 C1	435,69	E KDS 90 200 C1	442,96	E KDS 90 220 C1	502,77
* 1000 mm	E KDS 5050 180 C1	666,82	E KDS 5050 200 C1	673,51	E KDS 5050 220 C1	762,17
* 1200 mm	E KDS 6060 180 C1	715,07	E KDS 6060 200 C1	724,56	E KDS 6060 220 C1	821,57

* 1000 mm = 500+500 mm
* 1200 mm = 600+600 mm

FRONT DOOR AND BACK WALL SET MATERIAL LIST

Front Door	1 Pc
Back Wall	1 Pc
Door Lock Kit and Hinge Set	1 Pc
Assembly Screw Set	1 Set

OTHER DOOR OPTIONS



M2 Up-Down Perforated M3 Large Perforated C2 Glazed Perforated C3 Glazed Up-Down Perforated

REMARKS:

- Door options as above, ask your customer representative for the price.
- In the glazed doors uses 6 mm tempered glass.



E/D SERIES

FREE-STANDING MODULAR ENCLOSURES / IP 55

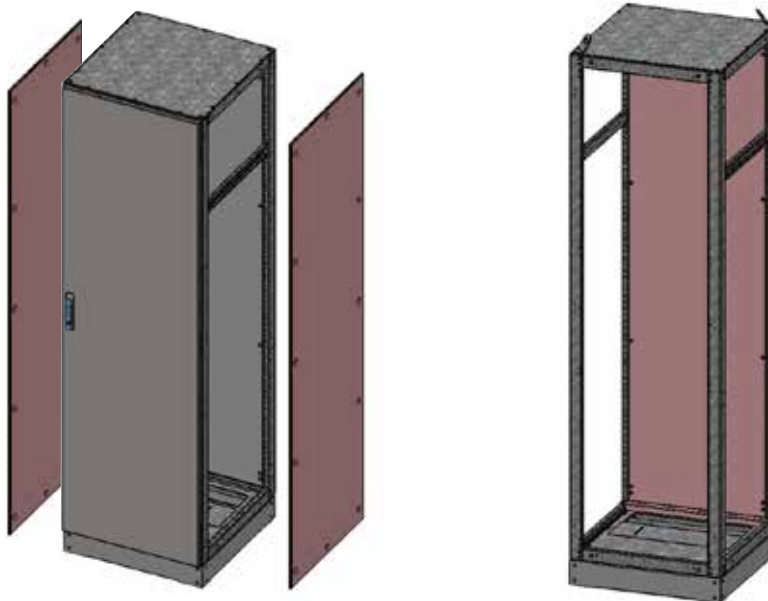

SIDE WALL SET MATERIAL LIST

Side Wall	2 Pcs
Assembly Screw Set	1 Set

SIDE WALL SETS / E - D SERIES

DEPTH	1400 mm HEIGHT		1600 mm HEIGHT		1800 mm HEIGHT		2000 mm HEIGHT		2200 mm HEIGHT	
	CODE	PRICE (\$)	CODE	PRICE (\$)	CODE	PRICE (\$)	CODE	PRICE (\$)	CODE	PRICE (\$)
400 mm	E YDS 40 140	97,21	E YDS 40 160	106,37	E YDS 40 180	112,23	E YDS 40 200	115,79	E YDS 40 220	131,94
500 mm	E YDS 50 140	111,13	E YDS 50 160	122,19	E YDS 50 180	129,43	E YDS 50 200	133,99	E YDS 50 220	153,13
600 mm	E YDS 60 140	125,06	E YDS 60 160	138,00	E YDS 60 180	146,63	E YDS 60 200	152,18	E YDS 60 220	174,31
800 mm	E YDS 80 140	152,91	E YDS 80 160	169,63	E YDS 80 180	181,03	E YDS 80 200	188,58	E YDS 80 220	216,67

BACK MOUNTING PLATE SET / E-D SERIES (2 mm)

WIDHT	1400 mm HEIGHT		1600 mm HEIGHT		1800 mm HEIGHT		2000 mm HEIGHT		2200 mm HEIGHT	
	CODE	PRICE (\$)	CODE	PRICE (\$)	CODE	PRICE (\$)	CODE	PRICE (\$)	CODE	PRICE (\$)
300 mm	E AMPS 30 140	54,67	E AMPS 30 160	58,03	E AMPS 30 180	61,43	E AMPS 30 200	63,64	E AMPS 30 220	72,25
400 mm	E AMPS 40 140	66,93	E AMPS 40 160	71,46	E AMPS 40 180	76,03	E AMPS 40 200	79,09	E AMPS 40 220	90,16
500 mm	E AMPS 50 140	79,18	E AMPS 50 160	84,89	E AMPS 50 180	90,62	E AMPS 50 200	94,53	E AMPS 50 220	108,06
600 mm	E AMPS 60 140	91,44	E AMPS 60 160	98,32	E AMPS 60 180	105,22	E AMPS 60 200	109,97	E AMPS 60 220	125,97
700 mm	E AMPS 70 140	103,69	E AMPS 70 160	111,75	E AMPS 70 180	119,81	E AMPS 70 200	125,41	E AMPS 70 220	143,88
800 mm	E AMPS 80 140	115,95	E AMPS 80 160	125,18	E AMPS 80 180	134,41	E AMPS 80 200	140,86	E AMPS 80 220	161,78
900 mm	E AMPS 90 140	128,21	E AMPS 90 160	138,61	E AMPS 90 180	149,00	E AMPS 90 200	156,30	E AMPS 90 220	179,69
1000 mm	E AMPS 100 140	140,46	E AMPS 100 160	152,04	E AMPS 100 180	163,60	E AMPS 100 200	171,74	E AMPS 100 220	197,60
1200 mm	E AMPS 120 140	164,97	E AMPS 120 160	178,90	E AMPS 120 180	192,79	E AMPS 120 200	202,63	E AMPS 120 220	233,41

BACK MOUNTING PLATE SET MATERIAL LIST

Back Mounting Plate	1 Pc
Back Mounting Plate Carrier	1 Pc
Assembly Screw Set	1 Set

HEIGHT PROFILE SET FRAME SET

D SERIES

FREE-STANDING MODULAR ENCLOSURES / IP 55



Technical Specifications

Sheet	Door	Enclosure	Mounting Plate
	1,5 mm CRS Sheet	1,5 mm 275 gr/m ² Galvanized Steel	2 mm 275 gr/m ² Galvanized Steel
Coating	RAL 7035 Wrinkle UV resistive polyester coating		
Surface Treatment	Nanoceramic coating / Zirconium oxide		
Protection Class	Indoor IP 55 (According to EN 60529 standards)		

FRAME SET

WIDHT	400 mm DEPTH	
	CODE	PRICE (\$)
400 mm	D KS 40 40 D	129,59
	D KS 40 40 F	132,74
500 mm	D KS 50 40 D	138,76
	D KS 50 40 F	142,15
600 mm	D KS 60 40 D	150,87
	D KS 60 40 F	154,50
700 mm	D KS 70 40 D	162,98
	D KS 70 40 F	166,86
800 mm	D KS 80 40 D	176,14
	D KS 80 40 F	179,74
1000 mm	D KS 100 40 D	208,88
	D KS 100 40 F	213,58
1200 mm	D KS 120 40 D	229,87
	D KS 120 40 F	235,05

FRAME SET

WIDHT	500 mm DEPTH	
	CODE	PRICE (\$)
400 mm	D KS 40 50 D	148,95
	D KS 40 50 F	152,34
500 mm	D KS 50 50 D	159,41
	D KS 50 50 F	163,09
600 mm	D KS 60 50 D	174,29
	D KS 60 50 F	178,25
700 mm	D KS 70 50 D	189,17
	D KS 70 50 F	193,41
800 mm	D KS 80 50 D	205,09
	D KS 80 50 F	209,09
1000 mm	D KS 100 50 D	246,39
	D KS 100 50 F	251,58
1200 mm	D KS 120 50 D	271,29
	D KS 120 50 F	277,05

FRAME SET

WIDHT	600 mm DEPTH	
	CODE	PRICE (\$)
400 mm	D KS 40 60 D	158,04
	D KS 40 60 F	161,68
500 mm	D KS 50 60 D	169,58
	D KS 50 60 F	173,54
600 mm	D KS 60 60 D	185,53
	D KS 60 60 F	189,82
700 mm	D KS 70 60 D	201,49
	D KS 70 60 F	206,10
800 mm	D KS 80 60 D	218,49
	D KS 80 60 F	222,90
1000 mm	D KS 100 60 D	261,93
	D KS 100 60 F	267,62
1200 mm	D KS 120 60 D	288,99
	D KS 120 60 F	295,32

HEIGHT PROFILE SET / E SERIES

HEIGHT	CODE	PRICE (\$)
1400 mm	D YPS 140	99,24
1600 mm	D YPS 160	103,78
1800 mm	D YPS 180	108,56
2000 mm	D YPS 200	111,17

HEIGHT PORFILE SET MATERIAL LIST

Height Profile	4 Pcs
Assembly Screw Set	1 Set

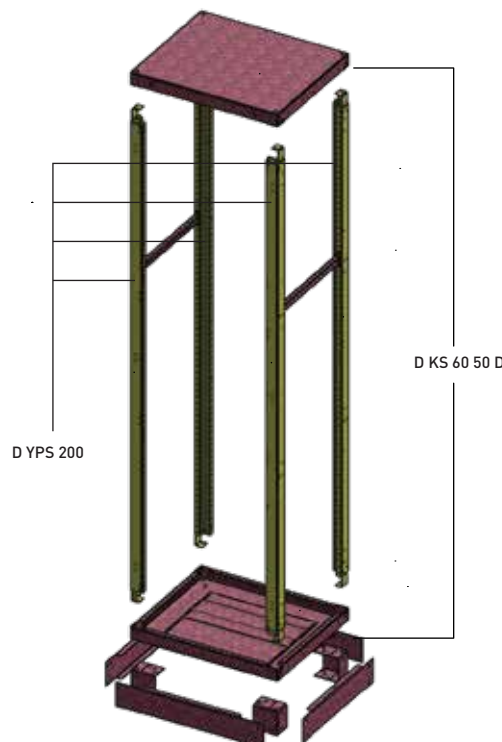

FRAME SET MATERIAL LIST

Bottom Tray	1 Pc
Top Tray (Plain or With Fan Cut-Out)	1 Pc
Plinth Corner (h100)	4 Pcs
Sliding Bottom Plate (With sealing tape)	1 Set
Front-Back Plinth Cover	2 Pcs
Side Plinth Cover	2 Pcs
Lifting Lug Single	2 Pcs
50 mm Mounting Bracket (Suitable for panel depth)	2 Pcs
Assembly Screw Set	1 Set

REMARKS:

- Mechanical assembly is subject to additional charge.
- Drilling & punching on the components is subject to additional charge.

PLAIN DOOR-BACK WALL SET (Door 2 mm / Back Wall 1 mm)



D
Plain

WIDHT	1400 mm HEIGHT FRONT DOOR-BACK WALL SET		1600 mm HEIGHT FRONT DOOR-BACK WALL SET		1800 mm HEIGHT FRONT DOOR-BACK WALL SET		2000 mm HEIGHT FRONT DOOR-BACK WALL SET	
	CODE	PRICE (\$)	CODE	PRICE (\$)	CODE	PRICE (\$)	CODE	PRICE (\$)
300 mm	D KDS 30 140 D	184,29	D KDS 30 160 D	189,19	D KDS 30 180 D	191,22	D KDS 30 200 D	190,22
400 mm	D KDS 40 140 D	241,81	D KDS 40 160 D	248,70	D KDS 40 180 D	254,76	D KDS 40 200 D	256,10
500 mm	D KDS 50 140 D	258,85	D KDS 50 160 D	267,66	D KDS 50 180 D	275,38	D KDS 50 200 D	277,91
600 mm	D KDS 60 140 D	275,89	D KDS 60 160 D	286,62	D KDS 60 180 D	295,99	D KDS 60 200 D	299,73
700 mm	D KDS 70 140 D	292,93	D KDS 70 160 D	305,58	D KDS 70 180 D	316,61	D KDS 70 200 D	321,54
800 mm	D KDS 80 140 D	309,97	D KDS 80 160 D	324,54	D KDS 80 180 D	337,23	D KDS 80 200 D	343,35
900 mm	D KDS 90 140 D	332,97	D KDS 90 160 D	350,12	D KDS 90 180 D	357,85	D KDS 90 200 D	365,17
* 1000 mm	D KDS 5050 140 D	539,33	D KDS 5050 160 D	559,48	D KDS 5050 180 D	576,90	D KDS 5050 200 D	583,37
* 1200 mm	D KDS 6060 140 D	573,50	D KDS 6060 160 D	597,50	D KDS 6060 180 D	618,24	D KDS 6060 200 D	627,11

* 1000 mm = 500+500 mm
* 1200 mm = 600+600 mm

PERFORATED DOOR-BACK WALL SET (Door 2 mm / Back Wall 1 mm)

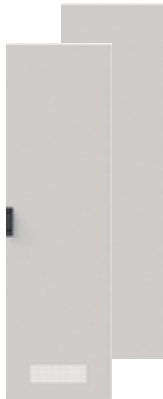

M1
Perforated

WIDHT	1800 mm HEIGHT FRONT DOOR-BACK WALL SET		2000 mm HEIGHT FRONT DOOR-BACK WALL SET	
	CODE	PRICE (\$)	CODE	PRICE (\$)
400 mm	D KDS 40 180 M1	264,99	D KDS 40 200 M1	265,88
500 mm	D KDS 50 180 M1	285,61	D KDS 50 200 M1	287,70
600 mm	D KDS 60 180 M1	306,23	D KDS 60 200 M1	309,51
700 mm	D KDS 70 180 M1	326,85	D KDS 70 200 M1	331,32
800 mm	D KDS 80 180 M1	347,47	D KDS 80 200 M1	353,14
900 mm	D KDS 90 180 M1	368,09	D KDS 90 200 M1	374,95
* 1000 mm	D KDS 5050 180 M1	587,31	D KDS 5050 200 M1	602,94
* 1200 mm	D KDS 6060 180 M1	628,12	D KDS 6060 200 M1	646,68

* 1000 mm = 500+500 mm
* 1200 mm = 600+600 mm

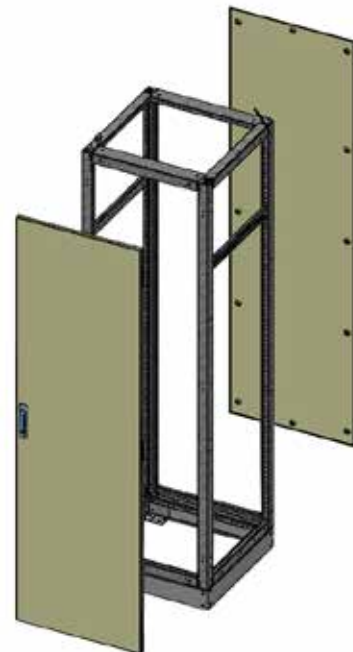

GLAZED DOOR-BACK WALL SET (Door 2 mm / Back Wall 1 mm)



C1
Glazed

WIDHT	1800 mm HEIGHT FRONT DOOR-BACK WALL SET		2000 mm HEIGHT FRONT DOOR-BACK WALL SET	
	CODE	PRICE (\$)	CODE	PRICE (\$)
500 mm	D KDS 50 180 C1	315,57	D KDS 50 200 C1	316,33
600 mm	D KDS 60 180 C1	336,18	D KDS 60 200 C1	338,14
700 mm	D KDS 70 180 C1	356,80	D KDS 70 200 C1	359,96
800 mm	D KDS 80 180 C1	377,42	D KDS 80 200 C1	381,77
900 mm	D KDS 90 180 C1	398,04	D KDS 90 200 C1	403,58
* 1000 mm	D KDS 5050 180 C1	617,09	D KDS 5050 200 C1	621,79
* 1200 mm	D KDS 6060 180 C1	658,43	D KDS 6060 200 C1	665,53

* 1000 mm = 500+500 mm
* 1200 mm = 600+600 mm

OTHER DOOR OPTIONS



M2 Up-Down Perforated **M3** Large Perforated **C2** Glazed Perforated **C3** Glazed Up-Down Perforated

FRONT DOOR AND BACK WALL SET MATERIAL LIST

Front Door	1 Pc
Back Wall	1 Pc
Door Lock Kit and Hinge Set	1 Pc
Assembly Screw Set	1 Set

REMARKS:

- Door options as above, ask your customer representative for the price.
- In the glazed doors uses 6 mm tempered glass.

INTERIOR MOUNTING EQUIPMENTS E/D SERIES

FREE-STANDING MODULAR ENCLOSURES / IP 55



MOUNTING PLATES

WIDTH	150 mm HEIGHT		200 mm HEIGHT		300 mm HEIGHT		400 mm HEIGHT		600 mm HEIGHT		800 mm HEIGHT		1200 mm HEIGHT	
	CODE	PRICE (\$)	CODE	PRICE (\$)	CODE	PRICE (\$)	CODE	PRICE (\$)	CODE	PRICE (\$)	CODE	PRICE (\$)	CODE	PRICE (\$)
300 mm	E MP 30 15	5,88	E MP 30 20	6,70	E MP 30 30	8,33	E MP 30 40	9,96	E MP 30 60	13,22	E MP 30 80	16,48	EMP 30 120	23,00
400 mm	E MP 40 15	6,90	E MP 40 20	7,99	E MP 40 30	10,15	E MP 40 40	12,32	E MP 40 60	16,65	E MP 40 80	20,99	EMP 40 120	29,65
500 mm	E MP 50 15	7,92	E MP 50 20	9,27	E MP 50 30	11,97	E MP 50 40	14,68	E MP 50 60	20,08	E MP 50 80	25,49	EMP 50 120	36,30
600 mm	E MP 60 15	8,94	E MP 60 20	10,56	E MP 60 30	13,80	E MP 60 40	17,04	E MP 60 60	23,51	E MP 60 80	29,99	EMP 60 120	42,95
700 mm	E MP 70 15	9,96	E MP 70 20	11,84	E MP 70 30	15,62	E MP 70 40	19,39	E MP 70 60	26,94	E MP 70 80	34,49	EMP 70 120	49,59
800 mm	E MP 80 15	10,98	E MP 80 20	13,13	E MP 80 30	17,44	E MP 80 40	21,75	E MP 80 60	30,37	E MP 80 80	39,00	EMP 80 120	56,24
1000 mm	E MP 100 15	13,01	E MP 100 20	15,70	E MP 100 30	21,09	E MP 100 40	26,47	E MP 100 60	37,24	E MP 100 80	48,00	EMP 100 120	69,53
1200 mm	E MP 120 15	15,05	E MP 120 20	18,28	E MP 120 30	24,73	E MP 120 40	31,19	E MP 120 60	44,10	E MP 120 80	57,01	EMP 120 120	82,83

INTERIOR MOUNTING EQUIPMENTS

PRODUCT NAME	300 mm WIDTH		400 mm WIDTH		500 mm WIDTH		600 mm WIDTH		700 mm WIDTH		800 mm WIDTH		PACKING QUANTITY
	CODE	PRICE (\$)	CODE	PRICE (\$)	CODE	PRICE (\$)	CODE	PRICE (\$)	CODE	PRICE (\$)	CODE	PRICE (\$)	
E/D Omega Mounting Plate	E OMP 30	14,92	E OMP 40	16,17	E OMP 50	17,42	E OMP 60	18,67	E OMP 70	19,92	E OMP 80	21,17	1
E/D Omega Rail Bracket	E ORA 30	2,75	E ORA 40	3,10	E ORA 50	3,44	E ORA 60	3,79	E ORA 70	4,14	E ORA 80	4,48	12
E/D Rail and Cable Holder	E RKT 30	2,99	E RKT 40	3,32	E RKT 50	3,66	E RKT 60	4,00	E RKT 70	4,33	E RKT 80	4,67	4
E/D Document Holder 20	-	-	E PC 42 Y	6,00	E PC 52 Y	6,95	E PC 62 Y	7,91	E PC 72 Y	8,86	E PC 82 Y	9,82	2
E/D Document Holder 60	-	-	E PC 46 Y	8,27	E PC 56 Y	9,50	E PC 66 Y	10,74	E PC 76 Y	11,97	E PC 86 Y	13,21	2
E/D Cable Duct Holder	-	-	-	-	E YDA 30 2	4,84	E YDA 40 2	4,91	E YDA 50 2	5,30	E YDA 60 2	6,10	2

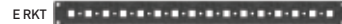

INTERIOR MOUNTING EQUIPMENTS

PRODUCT NAME	CODE	PRICE (\$)	PACKING QUANTITY
E/D Fixing Component	E TE	3,08	4
E/D Insulator Holder 200 mm	E TIT 20	2,60	12
E/D Insulator Holder 300 mm	E TIT 30	3,42	12
E/D Z Type Insulator Holder	E ZT	2,76	12
L Type Insulator Holder	E LT	1,84	24
Cable Holder 2000 mm	E KT 200	9,93	12
Device Lifter Type 1	E CY 1	12,60	1
Device Lifter Type 2	E CY 2	16,06	1
E/D Corner Support	E KSD	2,33	16
E/D Lighting Switch Holder	E ST	2,83	2
E/D Lifting Lug - Single	E MPT	1,68	2



COMBINING SETS

PRODUCT NAME	CODE	PRICE (\$)	PACKING QUANTITY
E/D Lifting Lug - Double	E MPC	2,09	2
E/D Combining Set 1	E BS 1	0,90	24
E/D Combining Set 2	E BS 2	2,37	24
E/D Combining Set 3	E BS 3	1,82	24



REMARKS:

- E PC X6: Used in automation enclosures.
- E PC X2: It is used together with cover plate in power distribution enclosures.

INTERIOR MOUNTING EQUIPMENTS

PRODUCT NAME	300 mm WIDTH		400 mm WIDTH		500 mm WIDTH		600 mm WIDTH		700 mm WIDTH		800 mm WIDTH		PACKING QUANTITY
	CODE	PRICE (\$)	CODE	PRICE (\$)	CODE	PRICE (\$)	CODE	PRICE (\$)	CODE	PRICE (\$)	CODE	PRICE (\$)	
C/B Omega Mounting Plate	C OMP 30	3,87	C OMP 40	5,09	C OMP 50	6,32	C OMP 60	7,54	C OMP 70	8,77	C OMP 80	9,99	1
C Horizontal Mounting Plate	C YMP 30 15	3,47	C YMP 40 15	5,02	C YMP 50 15	6,30	C YMP 60 15	7,33	C YMP 70 15	8,87	C YMP 80 15	10,16	1
C Horizontal Mounting Plate	C YMP 30 20	4,30	C YMP 40 20	5,68	C YMP 50 20	7,58	C YMP 60 20	9,23	C YMP 70 20	10,60	C YMP 80 20	12,51	1
C/B Omega Rail Bracket	C ORA 30 4	0,92	C ORA 40 4	1,14	C ORA 50 4	1,35	C ORA 60 4	1,56	C ORA 70 4	1,78	C ORA 80 4	1,99	12
Horizontal Bracket	C YAT 30	1,81	C YAT 40	2,30	C YAT 50	2,79	C YAT 60	3,28	C YAT 70	3,77	C YAT 80	4,27	12



C YAT



C YMP XX 20



C OMP XX



C ORA XX 4

SCREW SETS

PRODUCT NAME	CODE	PRICE (\$)	PACKING QUANTITY
Metric 5 Torx self tapping screws	M5 T	218,40	5000
Metric 6 Torx self tapping screws	M6 T	611,63	7500
Metric 10x20 Allen Imbus	M10x20 i	47,34	250
Metric 10x20 Hex Bolt	M10x20 A	35,77	200
Metric 10 Nut	M10 S	34,19	500
E-D Series Hinge	ED M	258,79	100
E-D Series Dual-Roller Catcher	ED KK	349,79	250

VERTICAL BRACKETS

HEIGHT	CODE	PRICE (\$)	PACKING QUANTITY
650 mm	E DAT 65	6,78	2
800 mm	E DAT 80	7,03	2
850 mm	E DAT 85	7,82	2
900 mm	E DAT 90	8,34	2
1000 mm	E DAT 100	9,12	2
1050 mm	E DAT 105	9,64	2
1200 mm	E DAT 120	10,41	2
1350 mm	E DAT 135	11,19	2
1550 mm	E DAT 155	12,48	2
1750 mm	E DAT 175	13,78	2
1950 mm	E DAT 195	14,29	2
2150 mm	E DAT 215	15,58	2



E DAT 100

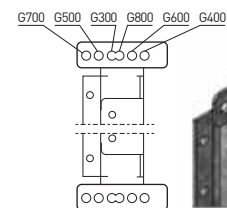
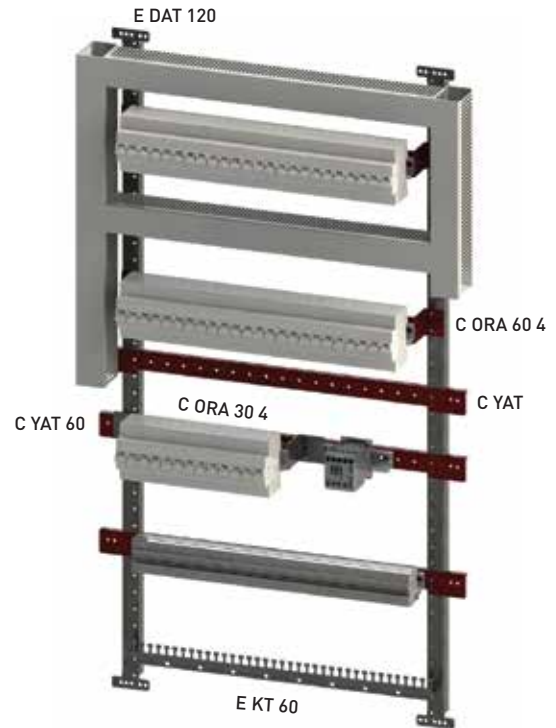

REMARKS:

- The connection hole of the vertical bracket varies according to the cover plate used. Please make your connection according to the technical drawing above.
- The dimensions given for the vertical bracket are the real measurement of the product. Other products are coded according to the enclosures size.

INTERIOR MOUNTING EQUIPMENTS

WIDTH	CAPASITOR PLATE			KIT FOR HEAVY EQUIPMENT			BASE PLATE FOR ACB			HORIZONTAL MOUNTING PLATE FOR NH FUSE		
	CODE	PRICE (\$)	PACKING QUANTITY	CODE	PRICE (\$)	PACKING QUANTITY	CODE	PRICE (\$)	PACKING QUANTITY	CODE	PRICE (\$)	PACKING QUANTITY
500 mm	E KA 50	7,44	4	E AEK 50	8,66	4	-	-	-	E SYA 50	7,79	2
600 mm	E KA 60	8,44	4	E AEK 60	9,92	4	E ATSA 60	21,40	1	E SYA 60	8,78	2
700 mm	E KA 70	9,44	4	E AEK 70	11,17	4	E ATSA 70	24,54	1	E SYA 70	9,78	2
800 mm	E KA 80	10,44	4	E AEK 80	12,42	4	E ATSA 80	27,68	1	E SYA 80	10,77	2
1000 mm	E KA 100	12,44	4	E AEK 100	14,92	4	-	-	-	E SYA 100	12,75	2
1200 mm	E KA 120	14,45	4	E AEK 120	17,43	4	-	-	-	E SYA 120	14,74	2

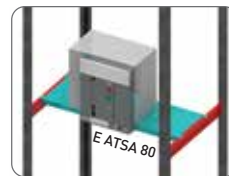
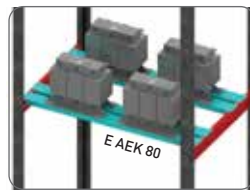

HEIGHT	VERTICAL MOUNTING PLATE FOR NH FUSE		
	CODE	PRICE (\$)	PACKING QUANTITY
1400 mm	E SYA 140	16,42	2
1600 mm	E SYA 160	18,59	2
1800 mm	E SYA 180	20,51	2
2000 mm	E SYA 200	22,42	2
2200 mm	E SYA 220	24,33	2

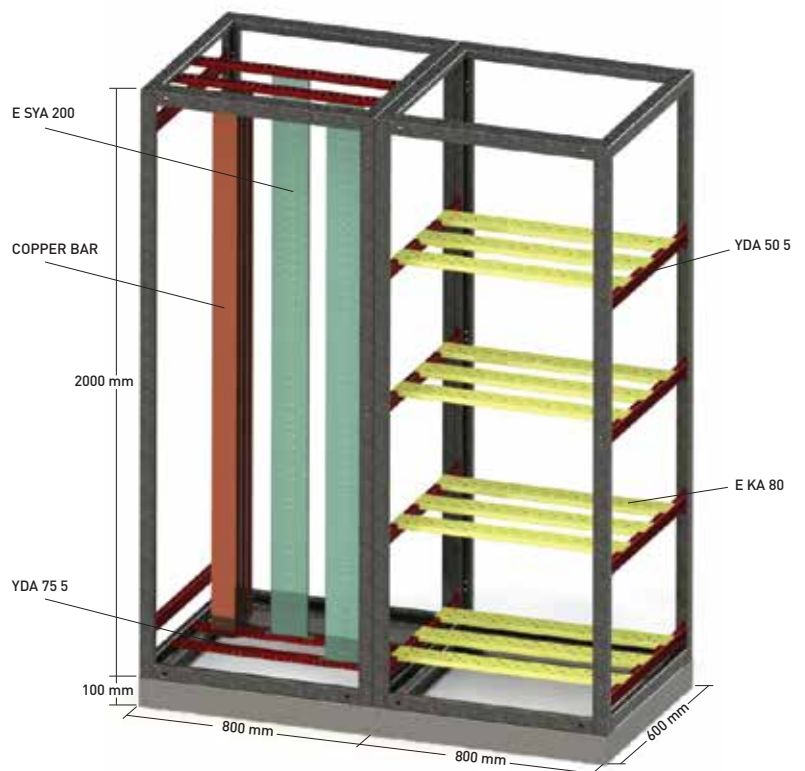
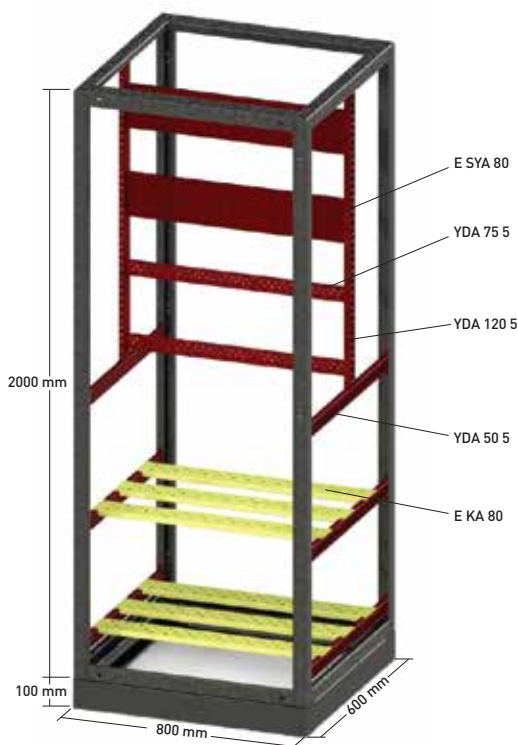



MOUNTING BRACKET

HEIGHT	25 mm WIDTH		PACKING QUANTITY
	CODE	PRICE (\$)	
300 mm	E YDA 30 2	4,84	2
350 mm	E YDA 35 2	5,05	2
400 mm	E YDA 40 2	4,91	2
450 mm	E YDA 45 2	5,47	2
500 mm	E YDA 50 2	5,30	2
550 mm	E YDA 55 2	5,89	2
600 mm	E YDA 60 2	6,10	2
650 mm	E YDA 65 2	6,31	2
700 mm	E YDA 70 2	6,53	2
750 mm	E YDA 75 2	6,74	2
800 mm	E YDA 80 2	6,95	2
850 mm	E YDA 85 2	7,16	2
900 mm	E YDA 90 2	7,37	2
950 mm	E YDA 95 2	7,58	2
1000 mm	E YDA 100 2	7,79	2
1050 mm	E YDA 105 2	8,00	2
1100 mm	E YDA 110 2	8,22	2
1150 mm	E YDA 115 2	8,43	2
1200 mm	E YDA 120 2	8,64	2



MOUNTING BRACKET

HEIGHT	50 mm WIDTH		PACKING QUANTITY
	CODE	PRICE (\$)	
300 mm	E YDA 30 5	5,71	2
350 mm	E YDA 35 5	6,02	2
400 mm	E YDA 40 5	5,90	2
450 mm	E YDA 45 5	6,64	2
500 mm	E YDA 50 5	6,48	2
550 mm	E YDA 55 5	7,26	2
600 mm	E YDA 60 5	8,75	2
650 mm	E YDA 65 5	9,15	2
700 mm	E YDA 70 5	9,56	2
750 mm	E YDA 75 5	9,96	2
800 mm	E YDA 80 5	10,37	2
850 mm	E YDA 85 5	10,77	2
900 mm	E YDA 90 5	11,17	2
950 mm	E YDA 95 5	11,58	2
1000 mm	E YDA 100 5	11,98	2
1050 mm	E YDA 105 5	12,39	2
1100 mm	E YDA 110 5	12,79	2
1150 mm	E YDA 115 5	13,19	2
1200 mm	E YDA 120 5	13,60	2
1250 mm	E YDA 125 5	14,00	2
1300 mm	E YDA 130 5	14,41	2
1350 mm	E YDA 135 5	14,81	2
1400 mm	E YDA 140 5	15,22	2
1450 mm	E YDA 145 5	15,62	2
1500 mm	E YDA 150 5	16,02	2
1550 mm	E YDA 155 5	16,43	2
1600 mm	E YDA 160 5	16,83	2
1650 mm	E YDA 165 5	17,24	2
1700 mm	E YDA 170 5	17,64	2
1750 mm	E YDA 175 5	18,04	2
1800 mm	E YDA 180 5	18,45	2
1850 mm	E YDA 185 5	18,85	2
1900 mm	E YDA 190 5	19,26	2
1950 mm	E YDA 195 5	19,66	2
2000 mm	E YDA 200 5	20,06	2
2050 mm	E YDA 205 5	20,47	2
2100 mm	E YDA 210 5	20,87	2



CUT&USE PROFILE

HEIGHT	WIDTH	CODE	PRICE (\$)	PACKING QUANTITY
2000 mm	Cut & Use Profile 25	E KES 25	13,15	12
	Cut & Use Profile 50	E KES 50	18,69	12
	Fixing Part 25	E SE 25	2,26	12
	Fixing Part 50	E SE 50	2,32	12

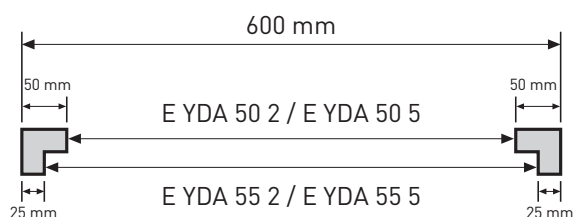

REMARK:
- The dimensions given for the mounting bracket are the real measurement of the product. Other products are coded according to the enclosures size.

COVER PLATES

B/C/D/E SERIES

ALL SERIES

yespan®

"thinking panels"



PLAIN COVER PLATES

HEIGHT	300 mm WIDTH		400 mm WIDTH		500 mm WIDTH		600 mm WIDTH		700 mm WIDTH		800 mm WIDTH	
	CODE	PRICE (\$)	CODE	PRICE (\$)	CODE	PRICE (\$)	CODE	PRICE (\$)	CODE	PRICE (\$)	CODE	PRICE (\$)
50 mm	E PS 30 5 D1	5,92	E PS 40 5 D1	6,20	E PS 50 5 D1	6,47	E PS 60 5 D1	6,75	E PS 70 5 D1	7,03	E PS 80 5 D1	7,30
100 mm	E PS 30 10 D1	6,61	E PS 40 10 D1	7,11	E PS 50 10 D1	7,60	E PS 60 10 D1	8,10	E PS 70 10 D1	8,59	E PS 80 10 D1	9,08
150 mm	E PS 30 15 D1	7,31	E PS 40 15 D1	8,02	E PS 50 15 D1	8,73	E PS 60 15 D1	9,44	E PS 70 15 D1	10,15	E PS 80 15 D1	10,86
200 mm	E PS 30 20 D1	8,00	E PS 40 20 D1	8,93	E PS 50 20 D1	9,86	E PS 60 20 D1	10,79	E PS 70 20 D1	11,72	E PS 80 20 D1	12,64
250 mm	E PS 30 25 D1	8,69	E PS 40 25 D1	9,84	E PS 50 25 D1	10,99	E PS 60 25 D1	12,13	E PS 70 25 D1	13,28	E PS 80 25 D1	14,43
300 mm	E PS 30 30 D1	9,65	E PS 40 30 D1	11,01	E PS 50 30 D1	12,38	E PS 60 30 D1	13,74	E PS 70 30 D1	15,11	E PS 80 30 D1	16,47
400 mm	E PS 30 40 D1	11,04	E PS 40 40 D1	12,83	E PS 50 40 D1	14,63	E PS 60 40 D1	16,43	E PS 70 40 D1	18,23	E PS 80 40 D1	20,03
500 mm	E PS 30 50 D1	12,68	E PS 40 50 D1	14,92	E PS 50 50 D1	17,15	E PS 60 50 D1	19,39	E PS 70 50 D1	21,62	E PS 80 50 D1	23,86
600 mm	E PS 30 60 D1	14,33	E PS 40 60 D1	17,00	E PS 50 60 D1	19,67	E PS 60 60 D1	22,34	E PS 70 60 D1	25,01	E PS 80 60 D1	27,68



RAIL TYPE COVER PLATES

HEIGHT	300 mm WIDTH		400 mm WIDTH		500 mm WIDTH		600 mm WIDTH		700 mm WIDTH		800 mm WIDTH	
	CODE	PRICE (\$)	CODE	PRICE (\$)	CODE	PRICE (\$)	CODE	PRICE (\$)	CODE	PRICE (\$)	CODE	PRICE (\$)
150 mm	E PS 30 15 R1	7,62	E PS 40 15 R1	8,33	E PS 50 15 R1	9,04	E PS 60 15 R1	9,76	E PS 70 15 R1	10,47	E PS 80 15 R1	11,18
200 mm	E PS 30 20 R1	8,37	E PS 40 20 R1	9,30	E PS 50 20 R1	10,23	E PS 60 20 R1	11,15	E PS 70 20 R1	12,08	E PS 80 20 R1	13,01
250 mm	E PS 30 25 R1	9,11	E PS 40 25 R1	10,26	E PS 50 25 R1	11,41	E PS 60 25 R1	12,55	E PS 70 25 R1	13,70	E PS 80 25 R1	14,85
300 mm	E PS 30 30 R1	10,17	E PS 40 30 R1	11,54	E PS 50 30 R1	12,90	E PS 60 30 R1	14,27	E PS 70 30 R1	15,63	E PS 80 30 R1	16,99
	6 Poles		12 Poles		18 Poles		24 Poles		30 Poles		36 Poles	



PERFORATED COVER PLATES

HEIGHT	300 mm WIDTH		400 mm WIDTH		500 mm WIDTH		600 mm WIDTH		700 mm WIDTH		800 mm WIDTH	
	CODE	PRICE (\$)	CODE	PRICE (\$)	CODE	PRICE (\$)	CODE	PRICE (\$)	CODE	PRICE (\$)	CODE	PRICE (\$)
100 mm	E PS 30 10 H1	6,61	E PS 40 10 H1	7,11	E PS 50 10 H1	7,60	E PS 60 10 H1	8,10	E PS 70 10 H1	8,59	E PS 80 10 H1	9,08

COVER PLATE FRAMES

HEIGHT	300 mm WIDTH		400 mm WIDTH		500 mm WIDTH	
	CODE	PRICE (\$)	CODE	PRICE (\$)	CODE	PRICE (\$)
1400 mm	E PSC 30 140 1	40,91	E PSC 40 140 1	42,58	E PSC 50 140 1	44,24
1600 mm	E PSC 30 160 1	44,03	E PSC 40 160 1	45,70	E PSC 50 160 1	47,36
1800 mm	E PSC 30 180 1	47,15	E PSC 40 180 1	48,82	E PSC 50 180 1	50,48
2000 mm	E PSC 30 200 1	50,27	E PSC 40 200 1	51,94	E PSC 50 200 1	53,60
2200 mm	E PSC 30 220 1	53,40	E PSC 40 220 1	55,06	E PSC 50 220 1	56,72

HEIGHT	600 mm WIDTH		700 mm WIDTH		800 mm WIDTH	
	CODE	PRICE (\$)	CODE	PRICE (\$)	CODE	PRICE (\$)
1400 mm	E PSC 60 140 1	45,90	E PSC 70 140 1	47,56	E PSC 80 140 1	49,22
1600 mm	E PSC 60 160 1	49,02	E PSC 70 160 1	50,68	E PSC 80 160 1	52,35
1800 mm	E PSC 60 180 1	52,14	E PSC 70 180 1	53,80	E PSC 80 180 1	55,47
2000 mm	E PSC 60 200 1	55,26	E PSC 70 200 1	56,92	E PSC 80 200 1	58,59
2200 mm	E PSC 60 220 1	58,38	E PSC 70 220 1	60,05	E PSC 80 220 1	61,71

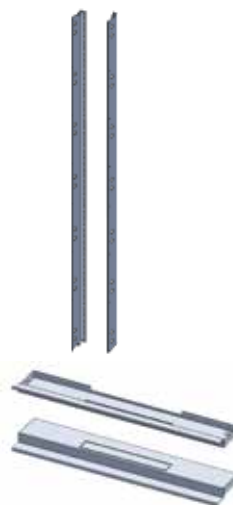

COVER PLATE FOR COPPER CELL

HEIGHT	200 mm WIDTH	
	CODE	PRICE (\$)
1600 mm	E PS 20 160 D1	14,35
1800 mm	E PS 20 180 D1	15,21
2000 mm	E PS 20 200 D1	20,23
2200 mm	E PS 20 220 D1	21,50



E PS 20 200 D1

COVER PLATE FRAME MATERIAL LIST

Vertical Frame Bracket	2 Pcs
Horizontal Frame Bracket	2 Pcs
Assembly Screw Set	1 Set

REMARKS:

- 50 mm loss should be calculated when ordering B/C Series cover plates.
- 150 mm loss should be calculated when ordering E/D Series cover plates.
- All products on this page are packaged in 1 piece.

C SERIES MATERIAL LIST

Main Enclosures	1 Pc
Door	1 Pc
Bottom Plate	1 Pc
Top Cover	1 Pc
Vertical Bracket	2 Pcs
Cover Plate Frame	1 Pcs
Cover Plates	1 Set
Omega Rail Bracket	1 Set
DIN-Rail	1 Set
Document Holder	1 Pc
Wall Mounting Bracket	4 Pcs
Assembly Screw Set	1 Set

Technical Specifications

Sheet	Enclosure /Door	Mounting Plate
	1,0 mm CRS Sheet	1,5 mm 275 gr/m ² Galvanized Steel
Coating	RAL 7035 Wrinkle UV resistive polyester coating	
Surface Treatment	Nanoceramic coating / Zirconium oxide	

C SERIES WALL MOUNTED DISTRIBUTION ENCLOSURES / IP41

PRODUCT CODE	CD 50 65 25	CD 50 90 25	CD 60 90 25	CD 60 105 25	CD 60 120 25
DIMENSIONS	500 x 650 x 250	500 x 900 x 250	600 x 900 x 250	600 x 1050 x 250	600 x 1200 x 250
POLES	36 Poles	54 Poles	72 Poles	96 Poles	120 Poles
PRICE (\$)	213,32	254,25	274,25	306,05	334,57

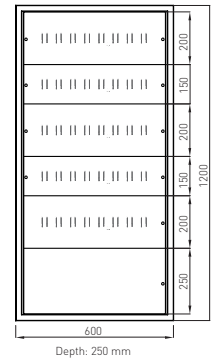
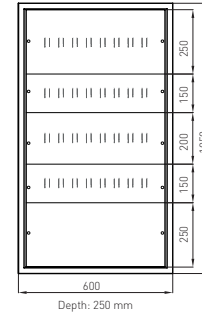
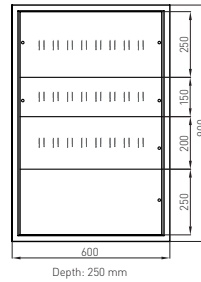
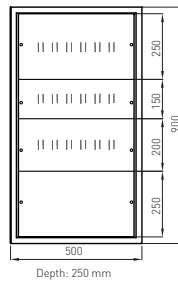
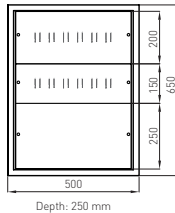

Technical Specifications

Sheet	Door	Enclosure / Mounting Plate
	1,5 mm CRS Sheet	1,5 mm 275 gr/m ² Galvanized Steel
Coating	RAL 7035 Wrinkle UV resistive polyester coating	
Surface Treatment	Nanoceramic coating / Zirconium oxide	
Protection Class	Indoor IP 55 (According to EN 60529 standards)	

D SERIES MATERIAL LIST

Height Profile Set	1 Pc
Frame Set	1 Pc
Side Wall Set	1 Pc
Plain Door-Back Wall Set	1 Pc
Vertical Bracket	2 Pcs
Horizontal Bracket	2 Pcs
Cover Plates Frame	1 Pcs
Cover Plate	1 Set
Omega Rail Bracket	1 Set
Horizontal Mounting Plate	1 Pc
DIN-Rail	1 Set
Omega Mounting Plate	1 Pc
Document Holder	1 Pc
Assembly Screw Set	1 Set

D SERIES FREE-STANDING DISTRIBUTION ENCLOSURES

PRODUCT CODE	DD 60 180+10 30	DD 60 200+10 30
DIMENSIONS	600 x 1800+100 x 300	600 x 2000+100 x 300
POLES	120 Poles	144 Poles
PRICE (\$)	1.040,39	1.069,32

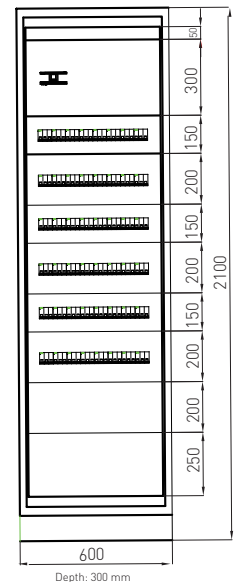
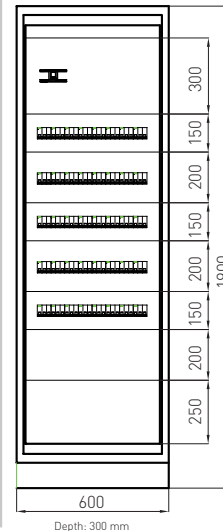

B SERIES

ENCLOSURES WITH MOUNTING PLATE / IP 66



Technical Specifications

Sheet	Enclosure / Door 1,0-1,5 mm CRS Sheet	Mounting Plate 1,5 mm 275 gr/m ² Galvanized Steel
Coating	RAL 7035 Wrinkle UV resistive polyester coating	
Surface Treatment	Nanoceramic coating / Zirconium oxide	
Protection Class	Indoor IP 66 (According to EN 60529 standards)	

B SERIES MATERIAL LIST

Enclosure	1 Pc
Door	1 Pc
Bottom Plate	1 Pc
Top Cover	1 Pc
Mounting Plate	1 Pc
Wall Mounting Bracket	4 Pcs
Earthing Cable	1 Pc
Assembly Screw Set	1 Set

	DIMENSIONS			ENCLOSURE	
	WIDTH	HEIGHT	DEPTH	CODE	PRICE (\$)
1 mm	300	400	200	B M 30 40 20	116,35
	400	500	200	B M 40 50 20	134,52
	400	600	200	B M 40 60 20	143,42
	400	600	300	B M 40 60 30	154,71
	500	600	200	B M 50 60 20	155,55
	500	700	200	B M 50 70 20	165,87
	500	700	300	B M 50 70 30	179,25
	600	800	200	B M 60 80 20	191,17
1,5 mm	600	800	300	B M 60 80 30	206,63
	600	1000	300	B M 60 100 30	268,74
	700	1000	200	B M 70 100 20	269,59
	700	1000	300	B M 70 100 30	291,85
	800	1000	300	B M 80 100 30	314,97
	800	1200	400	B M 80 120 40	379,80

OUTDOOR CANOPY SET		PLINTH SET		CABLE DUCT HOLDER	
CODE	PRICE (\$)	CODE	PRICE (\$)	CODE	PRICE (\$)
B S 30 20	12,88	B BS 30 20 Y	12,35	B KKA 30	2,33
B S 40 20	15,68	B BS 40 20 Y	13,36	B KKA 40	2,56
B S 40 20	15,68	B BS 40 20 Y	13,36	B KKA 40	2,56
B S 40 30	20,96	B BS 40 30 Y	19,05	B KKA 40	2,56
B S 50 20	18,48	B BS 50 20 Y	14,36	B KKA 50	2,79
B S 50 20	18,48	B BS 50 20 Y	14,36	B KKA 50	2,79
B S 50 30	24,96	B BS 50 30 Y	20,05	B KKA 50	2,79
B S 60 20	21,28	B BS 60 20 Y	15,36	B KKA 60	3,02
B S 60 30	28,97	B BS 60 30 Y	21,05	B KKA 60	3,02
B S 60 30	28,97	B BS 60 30 Y	21,05	B KKA 60	3,02
B S 70 20	24,08	B BS 70 20 Y	16,37	B KKA 70	3,25
B S 70 30	32,98	B BS 70 30 Y	22,06	B KKA 70	3,25
B S 80 30	36,98	B BS 80 30 Y	23,06	B KKA 80	3,48
B S 80 40	47,09	B BS 80 40 Y	30,30	B KKA 80	3,48

B SERIES:

Ask to customer representative for 316 quality stainless steel products.

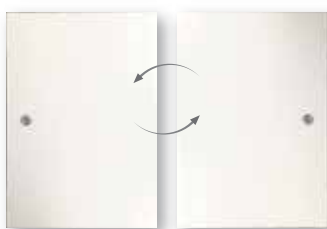

BIDIRECTIONAL

REMOVABLE CABLE GLAND PLATE



CANOPY



PLINTH

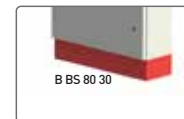

CABLE DUCT HOLDER



POLYURETHANE GASKET



WALL MOUNTING BRACKET

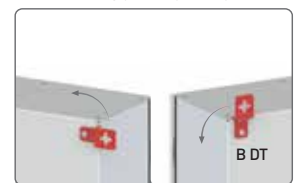

Technical Specifications

Sheet	Enclosure / Door 1 mm CRS Sheet	Mounting Plate 1,5 mm 275 gr/m ² Galvanized Steel
Coating	RAL 7035 Wrinkle UV resistive polyester coating	
Surface Treatment	Nanoceramic coating / Zirconium oxide	
Protection Class	Indoor IP 66 (According to EN 60529 standards)	



B SERIES:

Ask to customer representative for 316 quality stainless steel products.

B SERIES TERMINAL BOXES

DIMENSIONS			BOXES	
WIDTH	HEIGHT	DEPTH	CODE	PRICE (\$)
200	200	120	B K 20 20 12	90,71
300	200	120	B K 30 20 12	96,18
	300	120	B K 30 30 12	102,94
400	200	120	B K 40 20 12	103,53
	300	120	B K 40 30 12	109,84
	400	120	B K 40 40 12	118,02

E / D SERIES PARTITION SETS

E / D SERIES PARTITION SETS

DEPTH	HEIGHT 1400 mm		HEIGHT 1600 mm		HEIGHT 1800 mm		HEIGHT 2000 mm		HEIGHT 2200 mm	
	CODE	PRICE (\$)	CODE	PRICE (\$)	CODE	PRICE (\$)	CODE	PRICE (\$)	CODE	PRICE (\$)
400 mm	E BS 140 40	71,35	E BS 160 40	78,18	E BS 180 40	85,02	E BS 200 40	91,86	E BS 220 40	98,69
500 mm	E BS 140 50	74,76	E BS 160 50	81,60	E BS 180 50	88,44	E BS 200 50	95,27	E BS 220 50	102,11
600 mm	E BS 140 60	78,18	E BS 160 60	85,02	E BS 180 60	91,86	E BS 200 60	98,69	E BS 220 60	105,53
800 mm	E BS 140 80	85,02	E BS 160 80	91,86	E BS 180 80	98,69	E BS 200 80	105,53	E BS 220 80	112,37

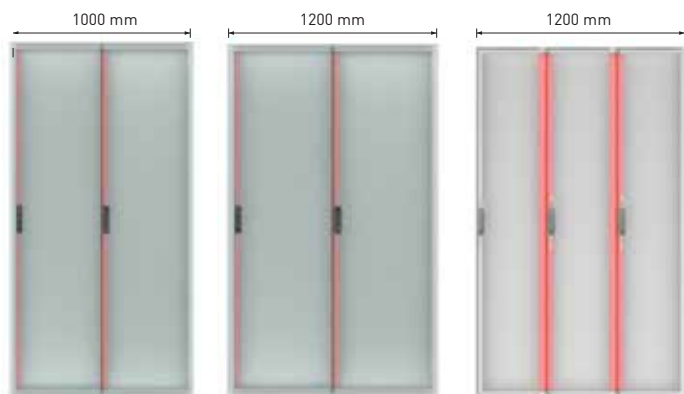

300 + 700
400 + 600
500 + 500

300 + 900
400 + 800
500 + 700
600 + 600

400 + 400 + 400
300 + 500 + 400
300 + 600 + 400

PARTITION SET MATERIAL LIST

Partition Set Vertical Bracket	2 Pcs
Partition Set Depth Bracket	2 Pcs
Assembly Screw Set	1 Set

Technical Specifications

Sheet	Enclosure / Door 1,5 mm CRS Sheet	Mounting Plate 2 mm 275 gr/m ² Galvanized Steel
Coating	RAL 7035 Wrinkle UV resistive polyester coating	
Surface Treatment	Nanoceramic coating / Zirconium oxide	



P SERIES / WITH BACK DOOR

DIMENSIONS			ENCLOSURES	
WIDTH	HEIGHT	DEPTH	CODE	PRICE (\$)
600	1300+100	500	P 60 140 50	2069,26
800	1300+100	500	P 80 140 50	2164,48
1000	1300+100	500	P 100 140 50	2259,69
1200	1300+100	500	P 120 140 50	2354,90
600	1300+100	600	P 60 140 60	2098,93
800	1300+100	600	P 80 140 60	2196,46
1000	1300+100	600	P 100 140 60	2293,99
1200	1300+100	600	P 120 140 60	2391,51

P SERIES MATERIAL LIST

Main Enclosures	1 Pc
Front Door	1 Pc
Middle Door	1 Pc
Back Door	1 Pc
Piano Type Console	1 Set
Mounting Plate Set	2 Set
Plinth Set	1 Set
Document Holder	1 Pc
Lock and Hinge Kit	4 Set
Assembly Screw Set	1 Set



T SERIES

DIMENSIONS			ENCLOSURES	
WIDTH	HEIGHT	DEPTH	CODE	PRICE (\$)
600	1000+100	500	T 60 110 50	1423,42
800	1000+100	500	T 80 110 50	1483,64
1000	1000+100	500	T 100 110 50	1543,87
1200	1000+100	500	T 120 110 50	1604,09
600	1000+100	600	T 60 110 60	1445,20
800	1000+100	600	T 80 110 60	1506,65
1000	1000+100	600	T 100 110 60	1568,10
1200	1000+100	600	T 120 110 60	1629,55

T SERIES MATERIAL LIST

Main Enclosures	1 Pc
Front Door	1 Pc
Mounting Plate Set	1 Set
Plinth Set	1 Set
Document Holder	1 Pc
Lock and Hinge Kit	4 Set
Assembly Screw Set	1 Set

P / T SERIES:

Ask to customer representative for 316 quality stainless steel products.

ALL SERIES

ACCESSORIES

	PRODUCT NAME	CODE	PRICE (\$)
	Panel Air Conditioner (1000 W)	G PK 1000	-
	Panel Air Conditioner (1500 W)	G PK 1500	-
	Panel Air Conditioner (2000 W)	G PK 2000	-
	Panel Air Conditioner (3000 W)	G PK 3000	-
	Roof Fans 5500 (IP44)	G TF 5500 IP44	-
	Roof Fans 6000 (IP44)	G TF 6000 IP44	-
	Roof Fans 5500 (IP54)	G TF 5500 IP54	-
	Roof Fans 6000 (IP54)	G TF 6000 IP54	-
	Ventilation Fan Filter 1000	G HFF 1000	-
	Ventilation Fan Filter 1500	G HFF 1500	-
	Ventilation Fan Filter 2000	G HFF 2000	-
	Ventilation Fan Filter 2500	G HFF 2500	-
	Ventilation Filter 1000	G HF 1000	-
	Ventilation Filter 1500	G HF 1500	-
	Ventilation Filter 2000	G HF 2000	-
	Ventilation Filter 2500	G HF 2500	-
	Thermostat (Close Contact / 10A)	G T NC	-
	Thermostat (Open Contact / 10A)	G T NO	-
	Thermostat (Double Contact / 10A)	G T NC NO	-
	Heater (230 V / 50 W)	G IS 50	-
	Heater (230 V / 75 W)	G IS 75	-
	Heater (230 V / 100 W)	G IS 100	-
	Heater (230 V / 150 W)	G IS 150	-
	Hygrostat	G HG	-
	Lighting Fixture	E AT	-
	E Series Fan Module	E FM	-

REMARK: Ask to customer representative for accessories.

LIFTING



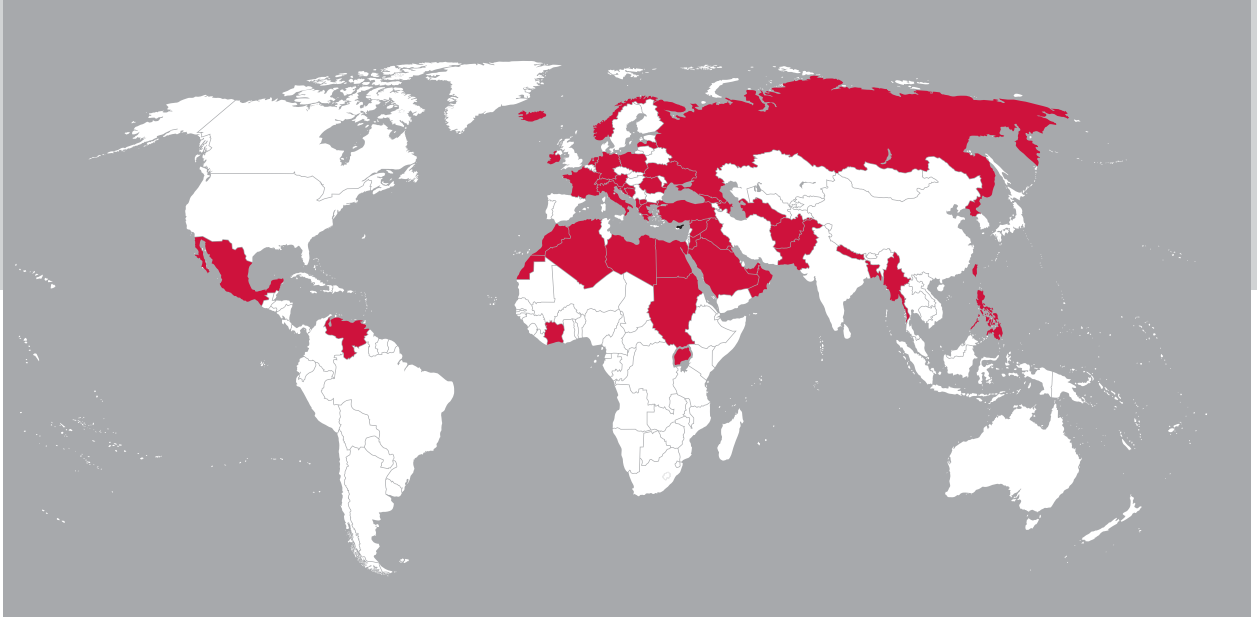

Yespan worldwide

We are at your service as a company whose products are used in more than 40 countries, and which has adopted the vision of a way of working that will make its business partners successful with its expert staff and production capabilities.



YESPAN ELEKTRİK SANAYİ VE TİCARET LTD. ŞTİ.

Head Office : Umurlu mahallesi Aydın OSB 2.Cadde No:41 09630 Efeler / AYDIN - TÜRKİYE
Tel: +90.256. 211 56 56 pbx • info@yespan.com

Branch : Perpa Ticaret Merkezi A Blok Kat: 11 No: 1667 Şişli / İSTANBUL - TÜRKİYE



